

AWM SERIES

- ▶ Ironless technology
- ▶ Vacuum Compatible (RGA tested)
- ▶ Zero cogging force
- ▶ Ironless linear motors with the highest motor constant and shortest coils lengths
- ▶ High continuous force and peak force

Introduction

AWM series linear motors are vacuum compatible ironless motors with no cogging force and high continuous/peak forces.

F_{cn} (Continuous force) = 4.5N ~ 414.8N

F_{pk} (Peak force) = 22.3N ~ 2986.3N

Features

- ▶ Vacuum compatible (RGA tested in 1×10^{-7} Torr vacuum)
- ▶ Ironless technology and no cogging force
- ▶ High continuous and peak force
- ▶ High motor constant
- ▶ Multiple coil lengths to select

Applications

Applicable to point-to-point micron/nanometer level positioning; unlimited travel stroke with top speed of 5m/s or faster; low velocity ripple during both fast and low speed scanning; precise force control with fine resolution.

Applications & Industries: front-end & back-end wafer handling and inspection, glass and LCD applications, and biomedical applications that require vacuum compatibility, high speed, precise motion and velocity control.

	Series	Coil Length (mm)	Continuous Force (F _{cn}) / PeakForce (F _{pk})						Unit: N
			10	50	100	200	300	400	
	AWM1-S1	43	4.5	22.3					
	AWM1-S2	85	8.9	44.7					
	AWM1-S3	127	13.4	67.0					
	AWM2-S1	61	13.5	67.4					
	AWM2-S2	121	27.0	134.9					
	AWM2-S3	181	40.5	202.3					
	AWM3-S1	121	47.0	240.1					
	AWM3-S2	241	94.0	480.2					
	AWM3-S3	361	140.9	720.4					
	AWM4-S1	121	79.6	397.9					
	AWM4-S2	241	159.2	795.8					
	AWM4-S3	361	238.7	1193.7					
	AWM5-S1	169	138.3	995.4					
	AWM5-S2	337	276	1990.9					
	AWM5-S3	505	414.8	2986.3					

Continuous force is measured under the condition of self-cooling.

AWM1

			AWM1-S1	AWM1-S2	AWM1-S3
Performance Parameters					
Continuous Force (NC) @100°C	F _{cn}	N	4.5	8.9	13.4
Peak Force	F _{pk}	N	22.3	44.7	67.0
Force Constant ±10%	K _f	N/Arms	2.6	5.3	7.9
Back EMF Constant ±10%	K _e	Vpeak/(m/s)	2.1	4.3	6.4
Motor Constant @25°C	K _m	N/Sqrt(W)	1.9	2.7	3.3
Resistance (L-L) 25°C ±10%	R ₂₅	Ω	1.3	2.5	3.75
Inductance (L-L) ±30%	L	mH	0.2	0.3	0.5
Electrical Time Constant	τ _e	ms	0.1	0.1	0.1
Continuous Current (NC) @100°C	I _{cn}	Arms	1.7	1.7	1.7
Peak Current	I _{pk}	Arms	8.5	8.5	8.5
Continuous Power Dissipation (NC) @100°C	P _{cn}	W	7.0	14.0	21.0
Max. Coil Temperature	t _{max}	°C	125.0	125.0	125.0
Thermal Dissipation Constant (NC)	K _{thn}	W/°C	0.1	0.2	0.3
Max. Bus Voltage	U _{bus}	Vdc	330.0	330.0	330.0
Magnetic Period	T _M	mm	21.0	21.0	21.0
Attraction Force	F _a	kN	0.0	0.0	0.0
Mechanical Parameters					
Coil Mass (NC)	m _{cn}	kg	0.02	0.04	0.06
Coil Length (NC)	L _{cn}	mm	43.0	85.0	127.0
Track Mass Per Meter	m _{track}	kg/m	2.9	2.9	2.9
Other Information					
Insulation Class	Class B (130°C)				
Protection Grade	IP00				
Compliance with Global Standards	RoHS, CE				
Ambient Temperature	Operation	0°C to 40°C (non-freezing)			
	Storage	-15°C to 70°C (non-freezing)			
Ambient Humidity	Operation	10%RH to 80%RH (non-condensing)			
	Storage	10%RH to 90%RH (non-condensing)			
Recommended Ambience	Indoor (no direct sunlight); No corrosive gas, inflammable gas, oil mist or dust.				

- Measurement is taken at ambient temperature 25°C. Value depends on the thermal environment.
 - Resistance is measured by DC current with standard 0.5 m cable.
 - Inductance is measured by current frequency of 1 kHz.
- The contents of datasheet are subject to change without prior notice.

Dimension

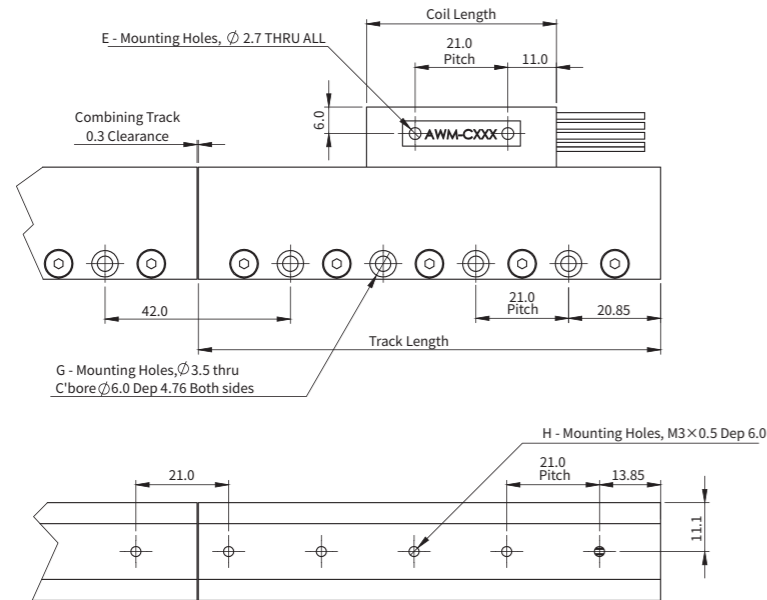

Motor Coil		
Model No	Coil Length	E
AWM1-S1	43.0	2
AWM1-S2	85.0	4
AWM1-S3	127.0	6

Motor Track			
Model No	Track Length	G	H
AWM1-TL63	62.7	2	3
AWM1-TL84	83.7	3	4
AWM1-TL105	104.7	4	5

Part Numbering

Motor Coil

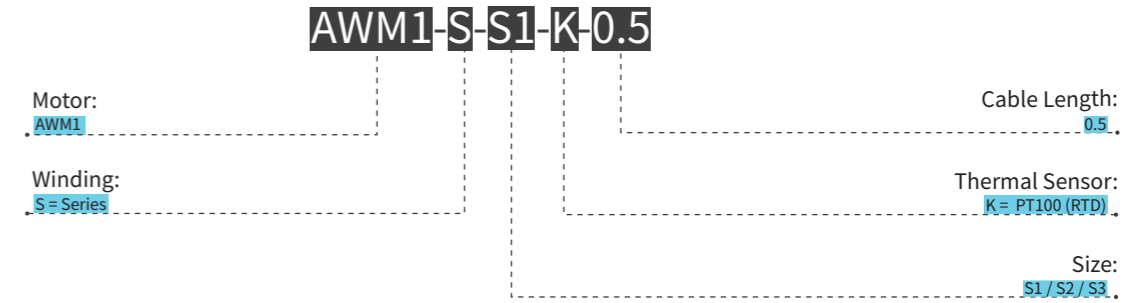

Motor Track



AWM2

Performance Parameters	Symbol	Unit	AWM2-S1		AWM2-S2		AWM2-S3	
			Series	Parallel	Series	Parallel	Series	Parallel
Continuous Force (NC) @100°C	F _{cn}	N	13.5	27.0	27.0	40.5	40.5	
Peak Force	F _{pk}	N	67.4	134.9	134.9	202.3	202.3	
Force Constant ±10%	K _f	N/Arms	8.4	16.9	8.4	25.3	8.4	
Back EMF Constant ±10%	K _e	Vpeak/(m/s)	6.9	13.8	6.9	20.6	6.9	
Motor Constant @25°C	K _m	N/Sqrt(W)	3.5	4.9	4.9	6.0	6.0	
Resistance (L-L) 25°C ±10%	R ₂₅	Ω	3.9	7.8	2.0	11.7	1.3	
Inductance (L-L) ±30%	L	mH	1.3	2.6	0.7	3.9	0.4	
Electrical Time Constant	τ _e	ms	0.3	0.3	0.3	0.3	0.3	
Continuous Current (NC) @100°C	I _{cn}	Arms	1.6	1.6	3.2	1.6	4.8	
Peak Current	I _{pk}	Arms	8.0	8.0	16.0	8.0	24.0	
Continuous Power Dissipation (NC) @100°C	P _{cn}	W	19.3	38.6	38.6	57.9	57.9	
Max. Coil Temperature	t _{max}	°C	125.0	125.0	125.0	125.0	125.0	
Thermal Dissipation Constant (NC)	K _{thn}	W/°C	0.3	0.5	0.5	0.8	0.8	
Max. Bus Voltage	U _{bus}	Vdc	330.0	330.0	330.0	330.0	330.0	
Magnetic Period	τ _{MN}	mm	30.0	30.0	30.0	30.0	30.0	
Attraction Force	F _a	kN	0.0	0.0	0.0	0.0	0.0	
Mechanical Parameters								
Coil Mass (NC)	m _{cn}	kg	0.06	0.13	0.13	0.19	0.19	
Coil Length (NC)	L _{cn}	mm	61.0	121.0	121.0	181.0	181.0	
Track Mass Per Meter	m _{track}	kg/m	4.9	4.9	4.9	4.9	4.9	
Other Information								
Insulation Class	Class B (130°C)							
Protection Grade	IP00							
Compliance with Global Standards	RoHS, CE							
Ambient Temperature	Operation	0°C to 40°C (non-freezing)						
	Storage	-15°C to 70°C (non-freezing)						
Ambient Humidity	Operation	10%RH to 80%RH (non-condensing)						
	Storage	10%RH to 90%RH (non-condensing)						
Recommended Ambience	Indoor (no direct sunlight); No corrosive gas, inflammable gas, oil mist or dust.							

- ① Measurement is taken at ambient temperature 25°C. Value depends on the thermal environment.
 - ② Resistance is measured by DC current with standard 0.5 m cable.
 - ③ Inductance is measured by current frequency of 1 kHz.
- The contents of datasheet are subject to change without prior notice.

Dimension

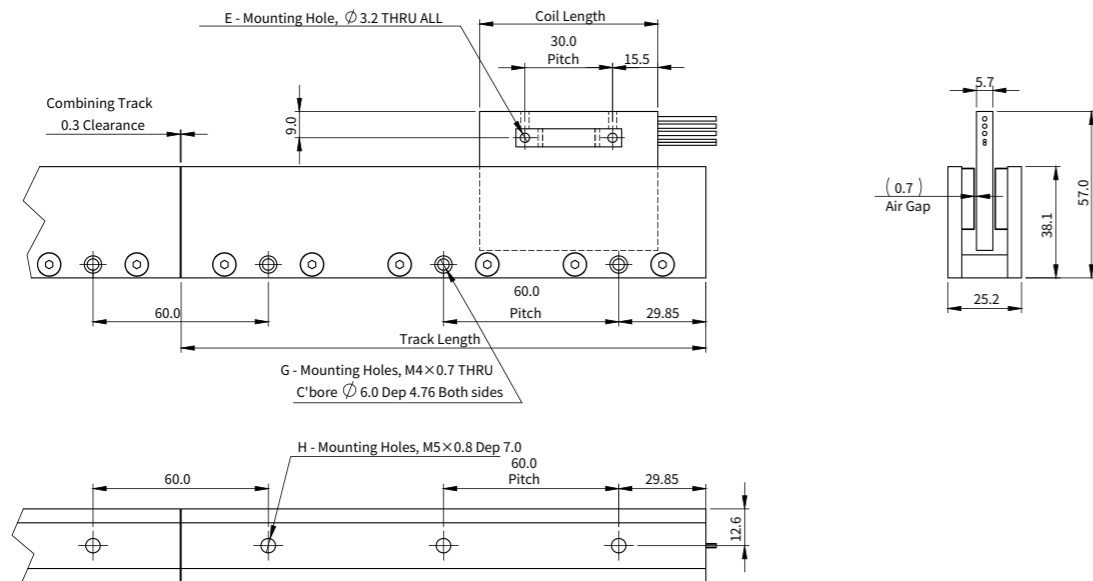

Motor Coil		
Model No	Coil Length	E
AWM2-S1	61.0	2
AWM2-S2	121.0	4
AWM2-S3	181.0	6

Motor Track			
Model No	Track Length	G	H
AWM2-TL120	119.7	2	2
AWM2-TL180	179.7	3	3
AWM2-TL240	239.7	4	4
AWM2-TL300	299.7	5	5

Part Numbering

Motor Coil

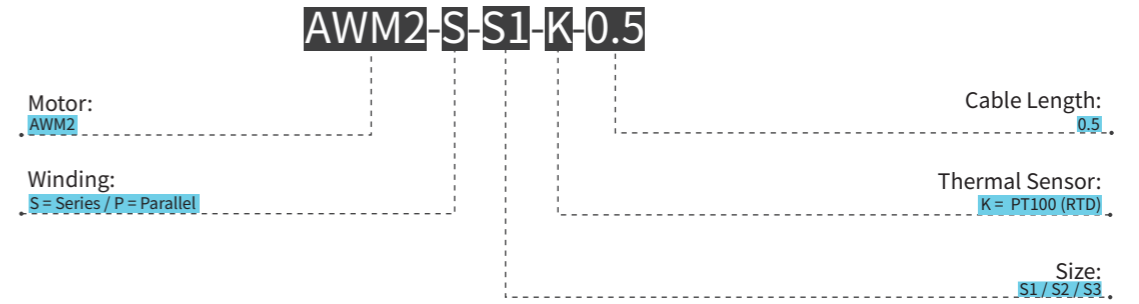

Motor Track

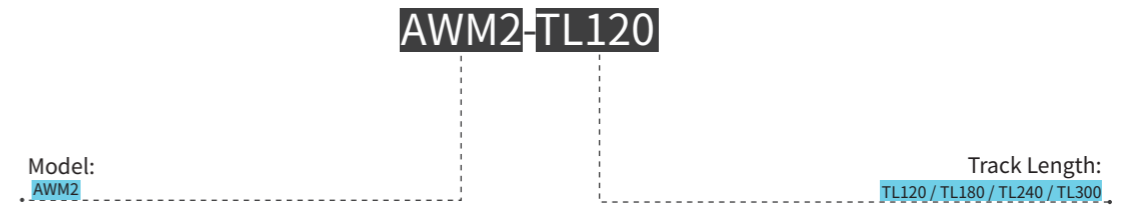

Introduction | Sizing Guide | Frequently Asked Questions | Linear Motors | Voice Coil Motors | Direct Drive Rotary Motors | Motion Control of Gantry Stages | Akribis systems

Introduction | Sizing Guide | Frequently Asked Questions | Linear Motors | Voice Coil Motors | Direct Drive Rotary Motors | Motion Control of Gantry Stages | Akribis systems

AWM3

			AWM3-S1	AWM3-S2		AWM3-S3	
Performance Parameters	Symbol	Unit	Series	Series	Parallel	Series	Parallel
Continuous Force (NC) @100°C	F _{cn}	N	47.0	94.0	94.0	140.9	140.9
Peak Force	F _{pk}	N	240.1	480.2	480.2	720.4	720.4
Force Constant ±10%	K _f	N/Arms	26.1	52.2	26.1	78.3	26.1
Back EMF Constant ±10%	K _e	Vpeak/(m/s)	21.3	42.6	21.3	63.9	21.3
Motor Constant @25°C	K _m	N/Sqrt(W)	7.7	10.9	10.9	13.3	13.3
Resistance (L-L) 25°C ±10%	R ₂₅	Ω	7.7	15.4	3.9	23.1	2.6
Inductance (L-L) ±30%	L	mH	5.9	11.8	3.0	17.7	2.0
Electrical Time Constant	τ _e	ms	0.8	0.8	0.8	0.8	0.8
Continuous Current (NC) @100°C	I _{cn}	Arms	1.8	1.8	3.6	1.8	5.4
Peak Current	I _{pk}	Arms	9.0	9.0	18.0	9.0	27.0
Continuous Power Dissipation (NC) @100°C	P _{cn}	W	48.2	96.5	96.5	144.7	144.7
Max. Coil Temperature	t _{max}	°C	125.0	125.0	125.0	125.0	125.0
Thermal Dissipation Constant (NC)	K _{thn}	W/°C	0.6	1.3	1.3	1.9	1.9
Max. Bus Voltage	U _{bus}	Vdc	330.0	330.0	330.0	330.0	330.0
Magnetic Period	T _{MN}	mm	60.0	60.0	60.0	60.0	60.0
Attraction Force	F _a	kN	0.0	0.0	0.0	0.0	0.0
Mechanical Parameters							
Coil Mass (NC)	m _{cn}	kg	0.24	0.48	0.48	0.71	0.71
Coil Length (NC)	L _{cn}	mm	121.0	241.0	241.0	361.0	361.0
Track Mass Per Meter	m _{track}	kg/m	8.75	8.75	8.75	8.75	8.75
Other Information							
Insulation Class	Class B (130°C)						
Protection Grade	IP00						
Compliance with Global Standards	RoHS, CE						
Ambient Temperature	Operation	0°C to 40°C (non-freezing)					
	Storage	-15°C to 70°C (non-freezing)					
Ambient Humidity	Operation	10%RH to 80%RH (non-condensing)					
	Storage	10%RH to 90%RH (non-condensing)					
Recommended Ambience	Indoor (no direct sunlight); No corrosive gas, inflammable gas, oil mist or dust.						

- Measurement is taken at ambient temperature 25°C. Value depends on the thermal environment.
 - Resistance is measured by DC current with standard 0.5 m cable.
 - Inductance is measured by current frequency of 1 kHz.
- The contents of datasheet are subject to change without prior notice.

Dimension

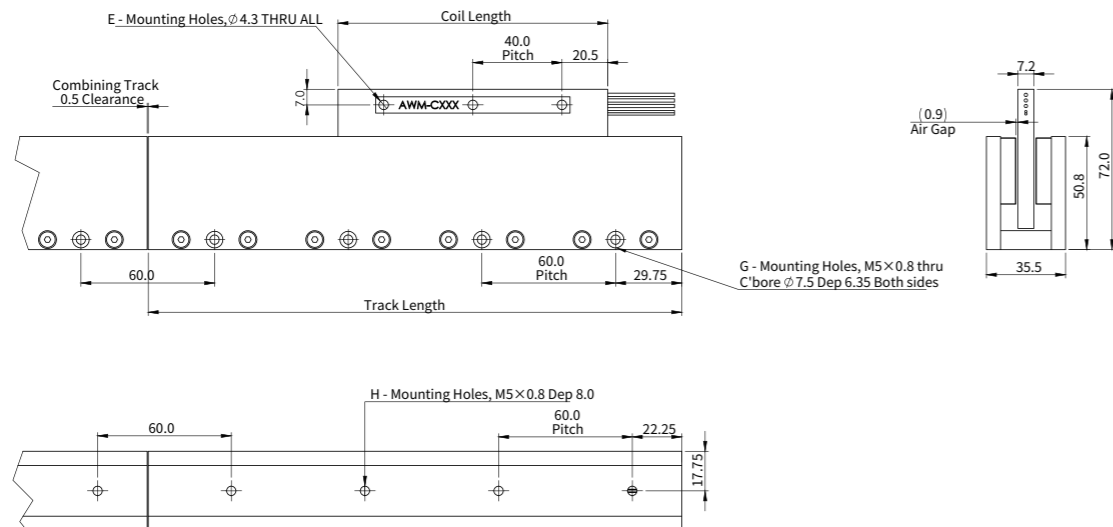

Motor Coil		
Model No	Coil Length	E
AWM3-S1	121.0	3
AWM3-S2	241.0	6
AWM3-S3	361.0	9

Motor Track			
Model No	Track Length	G	H
AWM3-TL180	179.5	3	3
AWM3-TL240	239.5	4	4
AWM3-TL300	299.5	5	5
AWM3-TL600	599.5	10	10

Part Numbering

Motor Coil



Motor Track

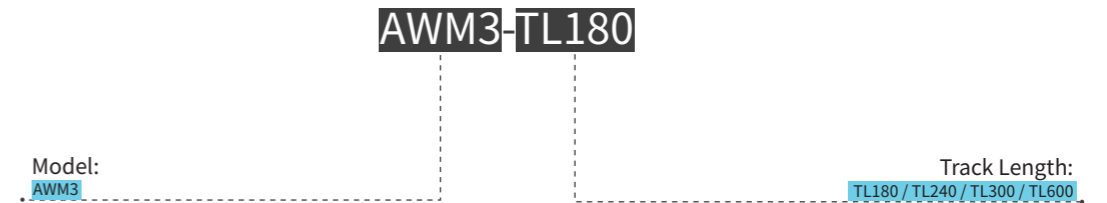

Introduction | Sizing Guide | Frequently Asked Questions | Linear Motors | Voice Coil Motors | Direct Drive Rotary Motors | Direct Drive Rotary Motors | Motion Control of Gantry Stages

Introduction | Sizing Guide | Frequently Asked Questions | Linear Motors | Voice Coil Motors | Direct Drive Rotary Motors | Direct Drive Rotary Motors | Motion Control of Gantry Stages

AWM4

			AWM4-S1	AWM4-S2	AWM4-S3
Performance Parameters			Series	Series	Parallel
Continuous Force (NC) @100°C	F _{cn}	N	79.6	159.2	238.7
Peak Force	F _{pk}	N	397.9	795.8	1193.7
Force Constant ±10%	K _f	N/Arms	34.6	69.2	103.8
Back EMF Constant ±10%	K _e	Vpeak/(m/s)	28.3	56.5	84.8
Motor Constant @25°C	K _m	N/Sqrt(W)	12.0	17.0	20.9
Resistance (L-L) 25°C ±10%	R ₂₅	Ω	5.5	11.0	16.5
Inductance (L-L) ±30%	L	mH	5.7	11.4	17.1
Electrical Time Constant	τ _e	ms	1.0	1.0	1.0
Continuous Current (NC) @100°C	I _{cn}	Arms	2.3	2.3	4.6
Peak Current	I _{pk}	Arms	11.5	11.5	23.0
Continuous Power Dissipation (NC) @100°C	P _{cn}	W	56.2	112.5	168.7
Max. Coil Temperature	t _{max}	°C	125.0	125.0	125.0
Thermal Dissipation Constant (NC)	K _{thn}	W/°C	0.7	1.5	2.2
Max. Bus Voltage	U _{bus}	Vdc	330.0	330.0	330.0
Magnetic Period	T _N	mm	60.0	60.0	60.0
Attraction Force	F _a	kN	0.0	0.0	0.0
Mechanical Parameters					
Coil Mass (NC)	m _{cn}	kg	0.34	0.68	1.01
Coil Length (NC)	L _{cn}	mm	121.0	241.0	361.0
Track Mass Per Meter	m _{track}	kg/m	14.72	14.72	14.72
Other Information			Class B (130°C)		
Insulation Class			IP00		
Protection Grade			RoHS, CE		
Compliance with Global Standards			0°C to 40°C (non-freezing)		
Ambient Temperature			-15°C to 70°C (non-freezing)		
Ambient Humidity			10%RH to 80%RH (non-condensing)		
Recommended Ambience			Indoor (no direct sunlight); No corrosive gas, inflammable gas, oil mist or dust.		

- Measurement is taken at ambient temperature 25°C. Value depends on the thermal environment.
 - Resistance is measured by DC current with standard 0.5 m cable.
 - Inductance is measured by current frequency of 1 kHz.
- The contents of datasheet are subject to change without prior notice.

Dimension

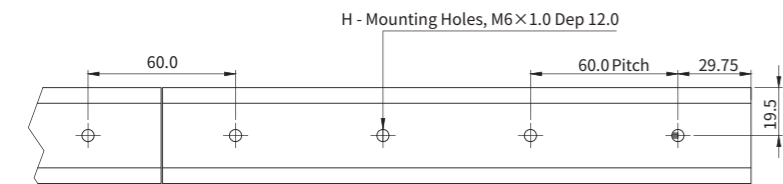
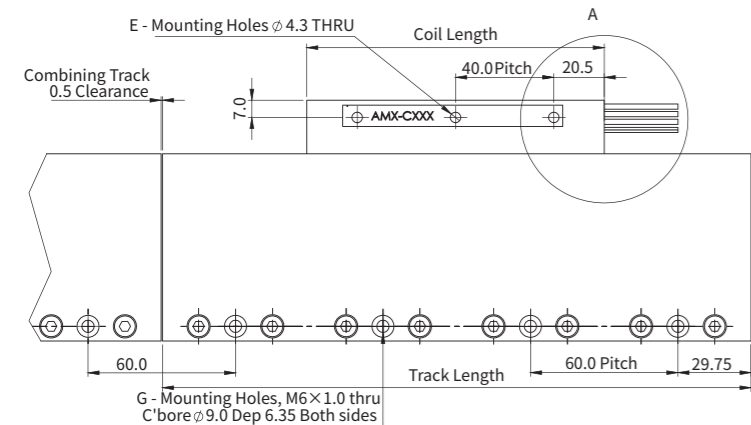

Motor Coil		
Model No	Coil Length	E
AWM4-S1	121.0	3
AWM4-S2	241.0	6
AWM4-S3	361.0	9

Motor Track			
Model No	Track Length	G	H
AWM4-TL180	179.5	3	3
AWM4-TL240	239.5	4	4
AWM4-TL300	299.5	5	5
AWM4-TL600	599.5	10	10

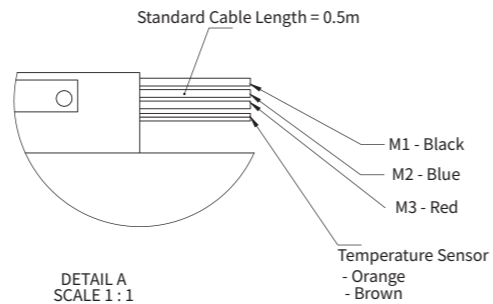
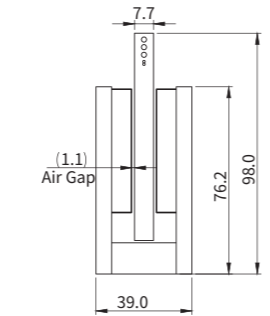

Part Numbering

Motor Coil



Motor Track

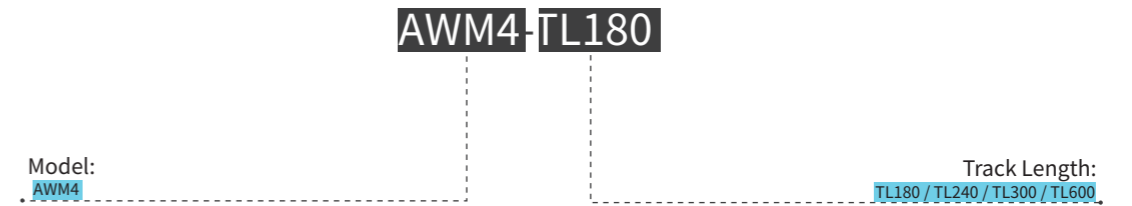

AWM5

Performance Parameters	Symbol	Unit	AWM5-S1		AWM5-S2		AWM5-S3	
			Series	Parallel	Series	Parallel	Series	Parallel
Continuous Force (NC) @100°C	F _{cn}	N	138.3	276.5	276.5	414.8	414.8	
Peak Force	F _{pk}	N	691.3	1382.5	1382.5	2073.8	2073.8	
Force Constant ±10%	K _f	N/Arms	55.3	110.6	55.3	165.9	55.3	
Back EMF Constant ±10%	K _e	Vpeak/(m/s)	45.2	90.3	45.2	135.5	45.2	
Motor Constant @25°C	K _m	N/Sqrt(W)	19.6	27.7	27.7	34.0	34.0	
Resistance (L-L) 25°C ±10%	R ₂₅	Ω	5.3	10.6	2.7	15.9	1.8	
Inductance (L-L) ±30%	L	mH	11.1	22.3	5.6	33.4	3.7	
Electrical Time Constant	T _e	ms	2.1	2.1	2.1	2.1	2.1	
Continuous Current (NC) @100°C	I _{cn}	Arms	2.5	2.5	5.0	2.5	7.5	
Peak Current	I _{pk}	Arms	12.5	12.5	25.0	12.5	37.5	
Continuous Power Dissipation (NC) @100°C	P _{cn}	W	64.0	128.1	128.1	192.1	192.1	
Max. Coil Temperature	t _{max}	°C	125.0	125.0	125.0	125.0	125.0	
Thermal Dissipation Constant (NC)	K _{thn}	W/°C	0.9	1.7	1.7	2.6	2.6	
Max. Bus Voltage	U _{bus}	Vdc	330.0	330.0	330.0	330.0	330.0	
Magnetic Period	T _{NN}	mm	84.0	84.0	84.0	84.0	84.0	
Attraction Force	F _a	kN	0.0	0.0	0.0	0.0	0.0	
Mechanical Parameters								
Coil Mass (NC)	m _{cn}	kg	0.88	1.76	1.76	2.64	2.64	
Coil Length (NC)	L _{cn}	mm	169.0	337.0	337.0	505.0	505.0	
Track Mass Per Meter	m _{track}	kg/m	25.08	25.08	25.08	25.08	25.08	
Other Information								
Insulation Class	Class B (130°C)							
Protection Grade	IP00							
Compliance with Global Standards	RoHS, CE							
Ambient Temperature	Operation	0°C to 40°C (non-freezing)						
	Storage	-15°C to 70°C (non-freezing)						
Ambient Humidity	Operation	10%RH to 80%RH (non-condensing)						
	Storage	10%RH to 90%RH (non-condensing)						
Recommended Ambience	Indoor (no direct sunlight); No corrosive gas, inflammable gas, oil mist or dust.							

- ① Measurement is taken at ambient temperature 25°C. Value depends on the thermal environment.
 - ② Resistance is measured by DC current with standard 0.5 m cable.
 - ③ Inductance is measured by current frequency of 1 kHz.
- The contents of datasheet are subject to change without prior notice.

Dimension

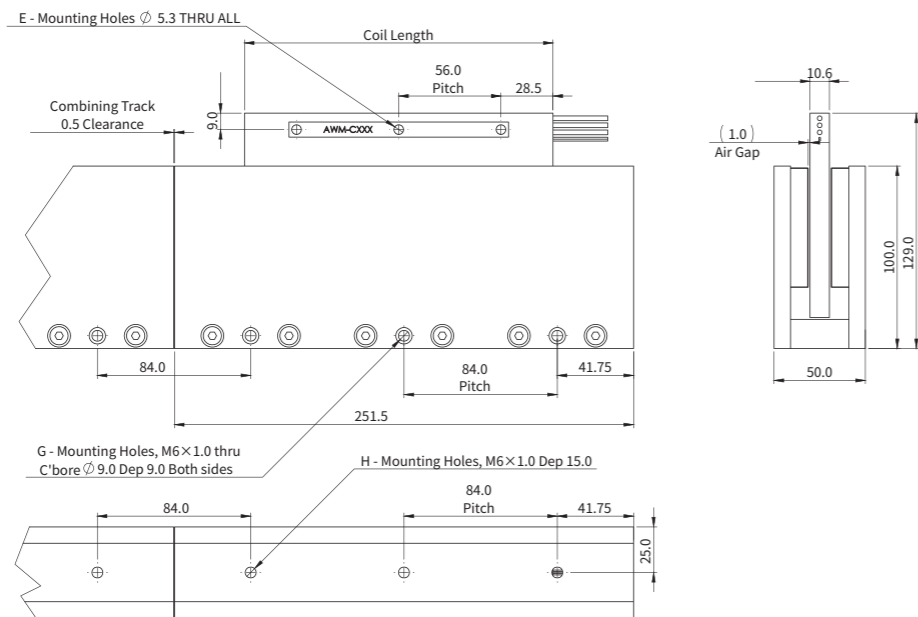

Motor Coil		
Model No	Coil Length	E
AWM5-S1	169.0	3
AWM5-S2	337.0	6
AWM5-S3	505.0	9

Motor Track			
Model No	Track Length	G	H
AWM5-TL252	251.5	3	3
AWM5-TL420	419.5	5	5
AWM5-TL588	587.5	7	7

Part Numbering

Motor Coil



Motor Track

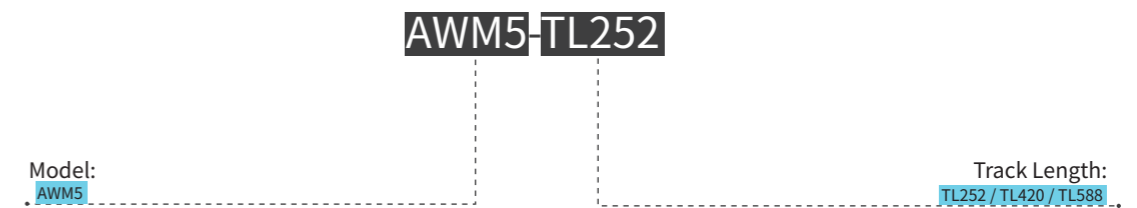

Motor Cable Connection

MOTOR CABLE		
PIN	DESCRIPTION	COLOR
-	M1	BLACK
-	M2	BLUE
-	M3	RED

TEMPERATURE SENSOR CABLE		
PIN	DESCRIPTION	COLOR
-	THERMAL	ORANGE
-	THERMAL	BROWN

